

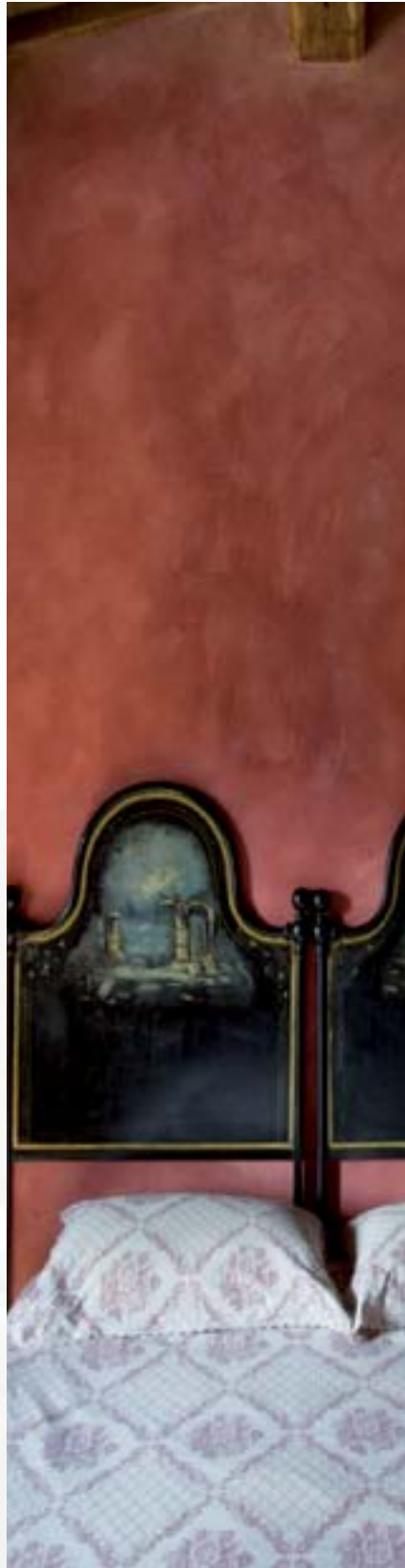

IL POGGIO TOSCANO

Mastgroup's
Luxury real
estate properties
in Tuscany





Introduction



Mastgroup is a real estate group with solid experience in developing, renting and selling residential real estate across Europe and North America with strong presence in the Czech Republic and Italy. Since 1986, Mastgroup continues to pursue in concrete visions.

Mastgroup is offering for sale a selection of exclusive properties in the central area of Tuscany where authenticity & tranquility still remain unspoiled:

- Casale Fornace, an elegant villa on a hilltop with Tuscan panoramic views
- Casale Santa Croce, a hidden jewel surrounded by nature and serenity
- Borghetto Poggio Bianco, a historical hamlet restored into 12 luxury countryside apartments

All 3 properties share in common a passion for authenticity with a touch of modernity: high quality fixtures and materials from the region have been used in combination with the presence of massive oak beams.

The properties are located in the municipality of Radicondoli, a peaceful medieval village with Etruscan origins. The area of Radicondoli is known for its authenticity and preserved wildlife. In many ways, Tuscany life continues in the traditional manner: authentic cuisine, friendly people and beautiful scenic roads with cypress trees. Siena is 25 minutes away, Florence 50 and Rome 3 hrs.

FORNACE

An elegant villa on a hilltop with Tuscan panoramic views.



DESCRIPTION

Villa 480 m2
Guest house 50 m2
Garage 180 m2
Swimming pool 15m x 8m
Land 9.725 m2
7 double bedrooms
8 bathrooms
6 parking

FACILITIES

Swimming pool
Terrace
Barbecue
Balcony
Fireplace
Central heating
Landscaped garden

PRICE

On request

Acquisition of 100% of shares
of the SPV
owning the property

LOCATION

Province of Siena:
+43° 13' 42.25",
+10° 57' 33.76"



Casale Fornace is a 17th Century farmhouse of 480 sqm on two floors and a guest house of 50 sqm, fully restored in 2007. Set on a hilltop with breathtaking panoramic views over the Tuscan hills, Casale Fornace represents the elegance of authentic Tuscan values. The main house is designed for luxurious countryside living and provides 6 double bedrooms, 7 bathrooms, open plan living areas, a large kitchen room, a cantina and an entrance hall. The main materials used in the renovation are: untreated terra cotta, polished stone, parquet, stucco, and oak. The guest house provides an additional double bedroom, a separate bathroom and living room.

FORNACE

An elegant villa on a hilltop with Tuscan panoramic views.

Ground Floor:

The characteristic of casale Fornace is its large kitchen area and cantina. The right part of the villa is flexible enough to create an independent living space with a double bedroom, a private bathroom and a living room. A small kitchen can easily be installed as the connections are pre set.

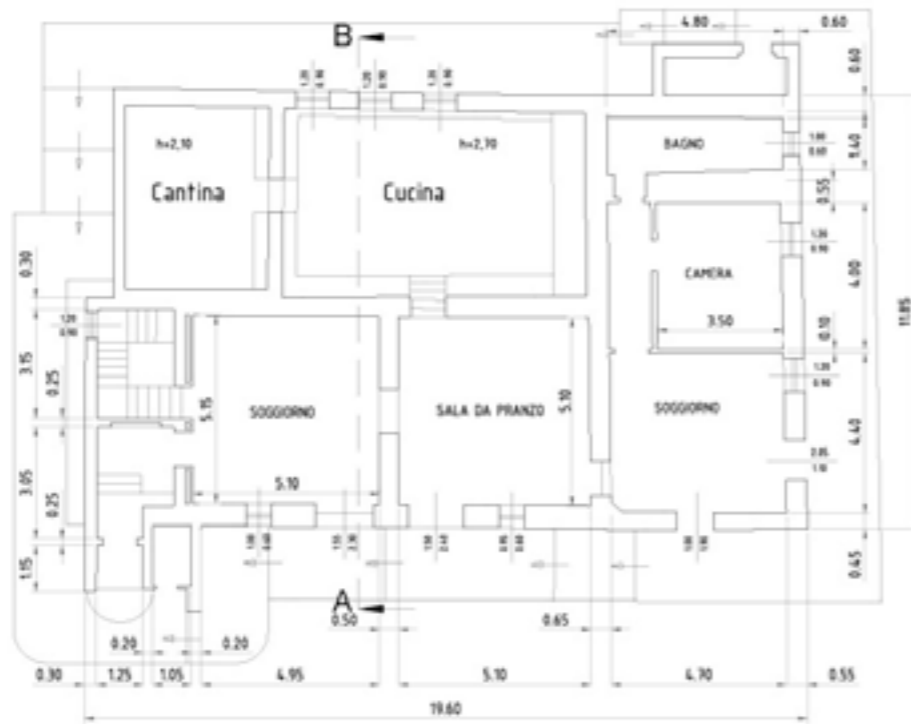

First Floor:

The chimney-living room is communal to all bedrooms. Each bedrooms are suites with views overlooking the hills. An additional separate bathroom is also available beside the chimney-living room.

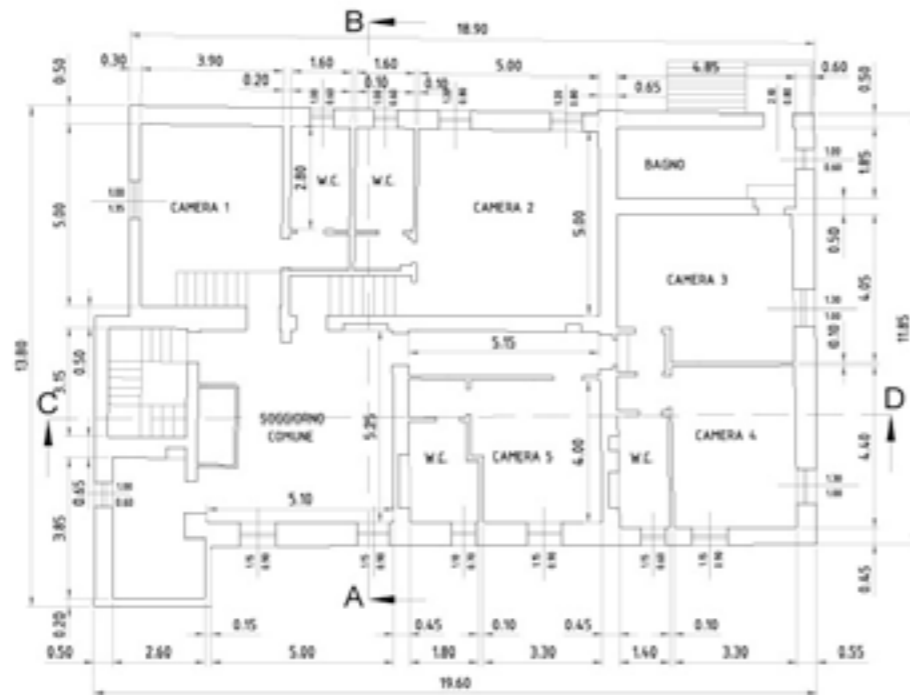

Garage underground:

The Garage can accommodate easily 6 cars and still have space for a dedicated laundry and storage area.

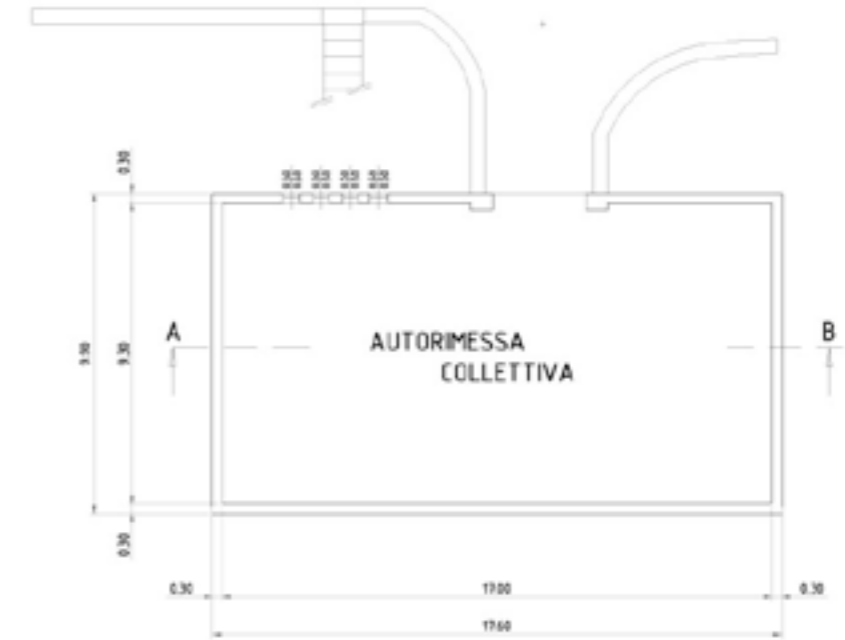

Guest house groundfloor:

The guest house is composed of a bedroom, a separate bathroom and a living room. Connections for installing a small kitchen are pre set. Adjacent, there is a large terra cotta terrace.

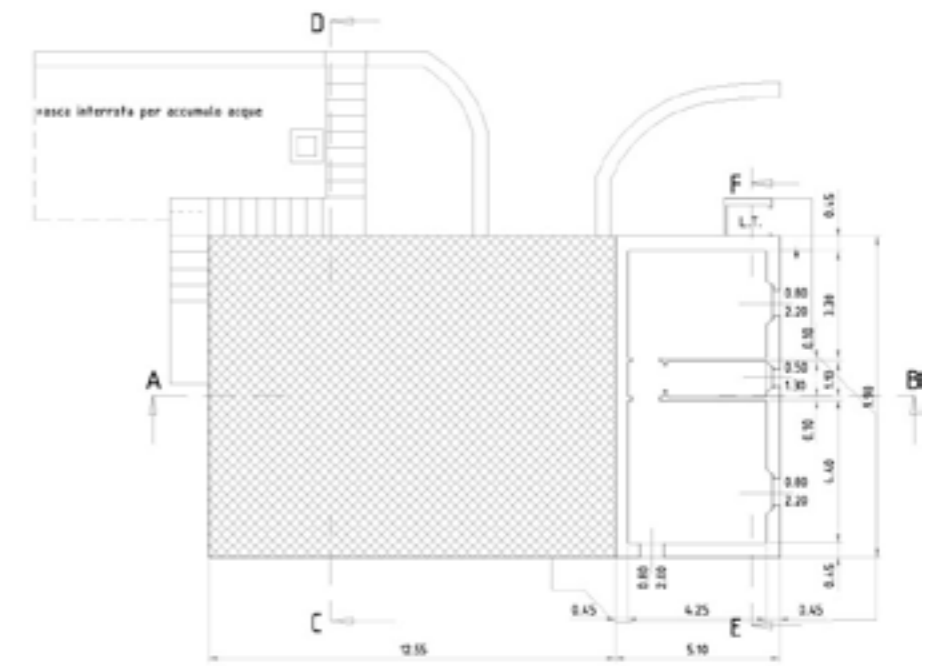

Swimming pool:

The main feature of this irregular 15m x 8m swimming pool are the roman style footsteps that lead into the water.

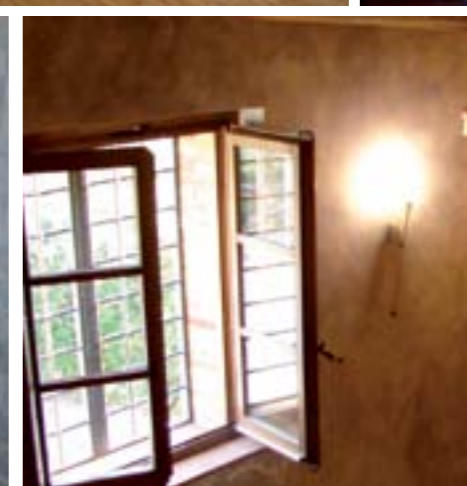
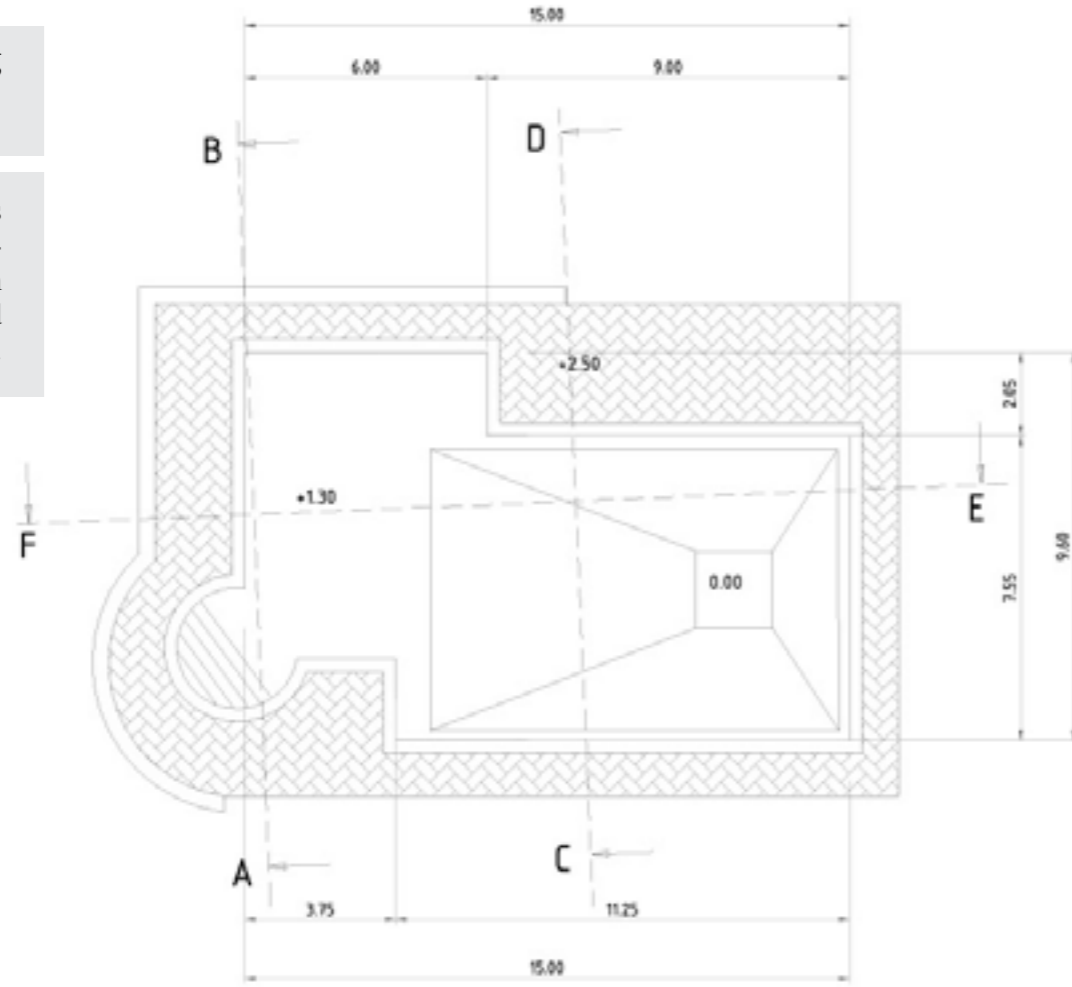

Santa croce

A hidden jewel surrounded by authenticity nature and serenity.

DESCRIPTION

Villa 264 m2
Guest house 37 m2
Garage 113 m2
Swimming pool 14m x 8m
Land 17.530 m2
5 double bedrooms
5 bathrooms
3 parquings

FACILITIES

Balcony
Fireplace
Exterior jacuzzi
Panoramic view
Swimming pool
Brick barbecue
Terraces

PRICE

On request

Acquisition of 100% of shares of the SPV owning the property

LOCATION

Province of Siena:
+43° 14' 24.89",
+11° 5' 28.48"

Santa Croce is a luxury “casale” (Italian word for countryside house) located in the South part of the Chianti countryside, in the province of Siena. Restored in 2007 with high quality features, this stunning villa with its separate guest house can accommodate up to 10 people, within 5 double bedroom suites. Santa Croce is literally surrounded by a natural oak and pine forest, located on a hill with breathtaking views on the Tuscan Valley and the medieval village of Belforte. Fully furnished, all rooms at Santa Croce feature beautiful antic furniture and unique design. The large swimming pool (16m x 6m) and the jacuzzi are strategically placed to admire the breathtaking views of the Tuscan countryside and the magnificent sunset.



Santa croce

A hidden jewel surrounded by authenticity nature and serenity.

Ground Floor:

The ground floor consists of a living room with original paintings and a cozy stone fire place. The dining area has a stunning oak table which can seat 10 people at once. There is also a large hall entrance and a sitting room which is an ideal place for after meal conversations.

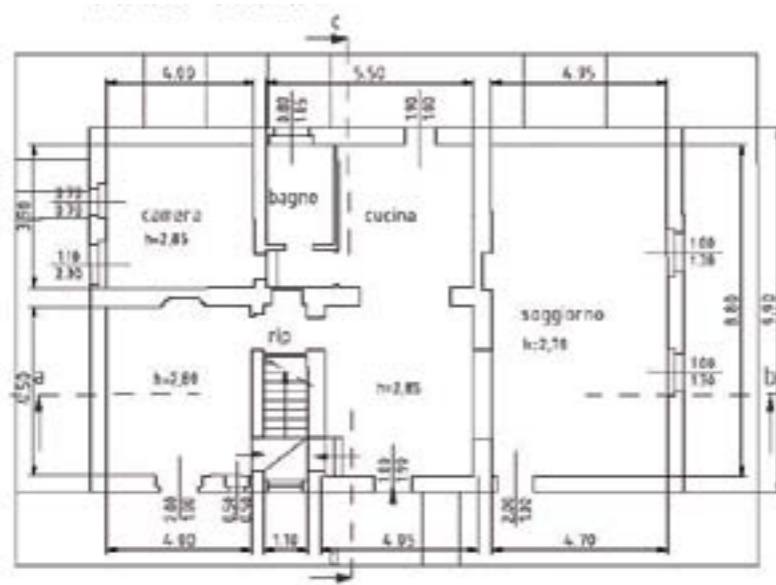

Guest house:

The guest house is located a few meters away from the main house. It is a lovely private house with a double bedroom, a living room with a rich wooden dining table and a separate bathroom.

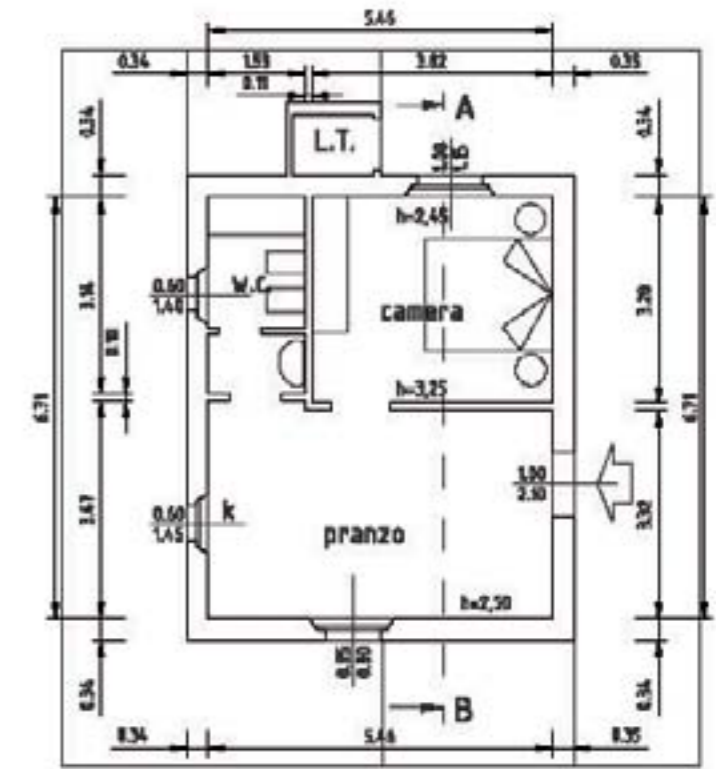

First Floor:

On the first floor are located the four double bedrooms, each unique in its design and each with its own private bathroom.

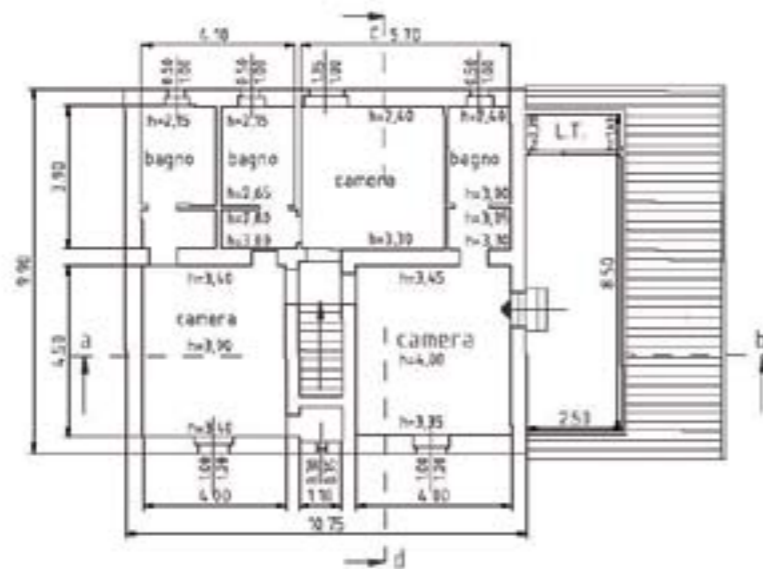

Garage:

The garage can fit up to 3 cars, as well as a laundry and store area.

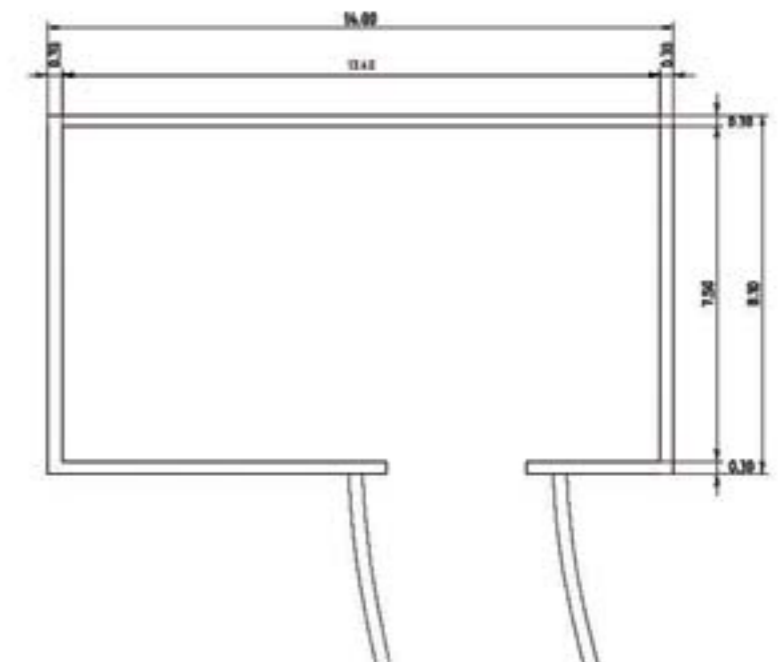

Swimming pool:

Surrounded by a garden of mixed wild flowers, the swimming pool is 14m x 8m.

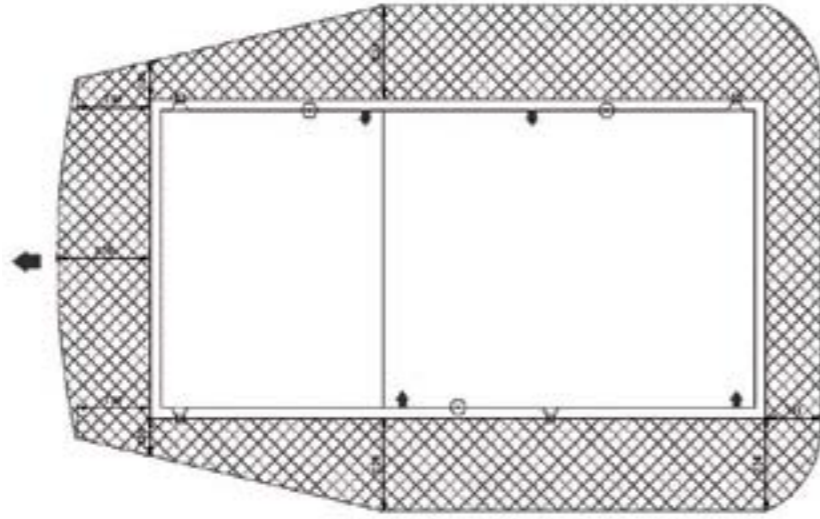

Borghetto Poggio Bianco

A historical hamlet restored into luxury countryside apartments.

DESCRIPTION

Living surface: 938 m²

Swimming pool: 18m x 6m

Land: 3.210 m²

Terraces & garden area: 647 m²

Total 12 units: Studio, 3 units

1-bedroom apartment, 5 units

2-bedroom apartment, 1 unit

3-bedroom apartment, 2 units

loft, 1 unit

PRICE

On request

Acquisition of 100% of shares of the SPV owning the property

FACILITIES

Fireplace

Exterior jacuzzi

Panoramic view

Swimming pool

Brick barbecue

Terraces

LOCATION

Province of Siena:

+43° 14' 22.98",

+11° 5' 7.05"



Borghetto Poggio Bianco is a 15th century old hamlet which has been restored in 2009 into 12 exclusive countryside apartments. The restoration of Poggio Bianco has retained the essence of the original features with the addition of excellent quality fixtures and furnishings, as well as massive oak roof beams. The hamlet and its large swimming pool & heated jacuzzi are surrounded by a beautiful unspoiled landscape and virgin forest making this place a unique base for a relaxing and authentic living in Tuscany. The property is reachable through a private road, 1 km long, starting from the beautiful castle of Falsini, whose only inhabitants are wild horses.

All 12 apartments, which can accommodate up to 36 people at a time, are unique in their design, colors, materials and sizes. There are all fully furnished and equipped with modern kitchen and appliances, ready to enjoy the minute you step in.

Borghetto Poggio Bianco

A historical hamlet restored into luxury countryside apartments.

Borghetto Poggio Bianco:

All 12 apartments have been designed respecting the original perimeters of the hamlet

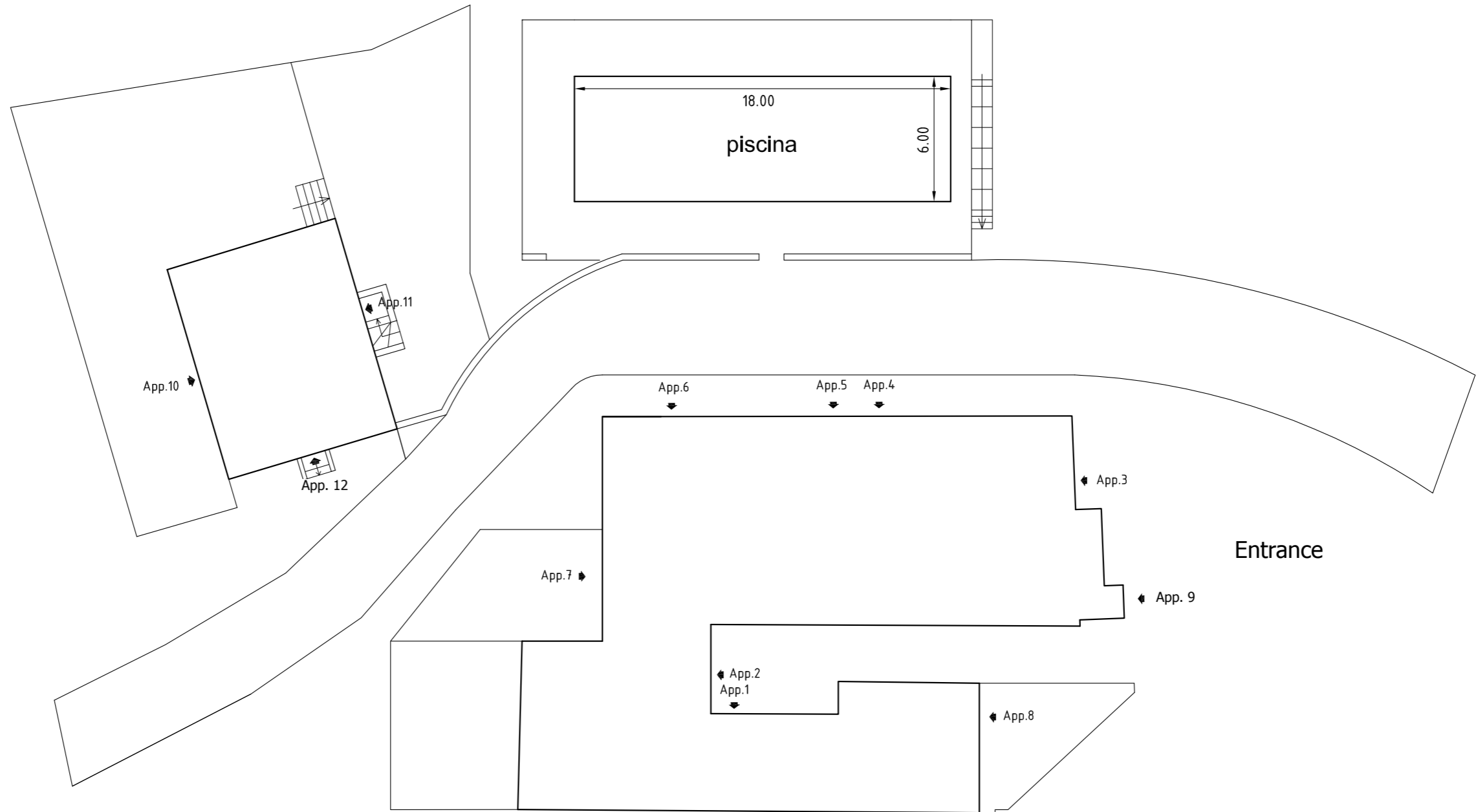

Borghetto Poggio Bianco

A historical hamlet restored into luxury countryside apartments.

Apartment one:

Type: studio with kitchen corner
 1 complete bathroom with shower
 Ground floor
 Size: 38 m²
 Terrace / garden: none

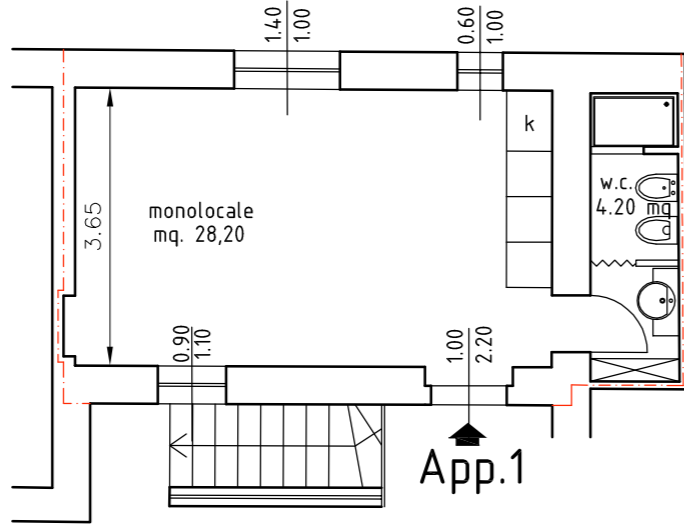

Apartment two:

Type: 2-bedroom apartment with kitchen corner, living room and terrace with garden
 1 complete bathroom with shower
 Ground floor
 Size: 65 m²
 Terrace & garden: 84 m²

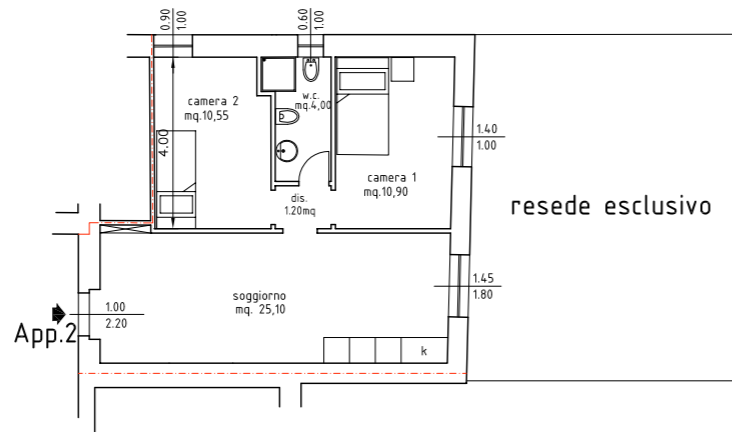

Apartment three:

Type: 1-bedroom apartment with kitchen corner, living room and terrace
 1 bathroom with shower
 Ground floor
 Size: 44 m²
 Terrace: 43 m²

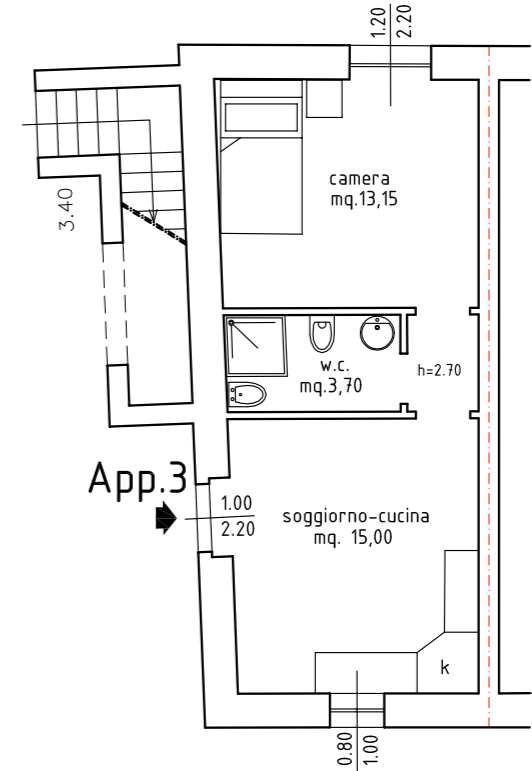

Apartment four:

Type: duplex 3-bedroom apartment with kitchen and dining area, living area, fireplace and terrace
 1 complete bathroom with shower
 1 private bathroom with shower and bath tub
 Ground floor and first floor
 Size: 118 m²
 Terrace: 19 m²

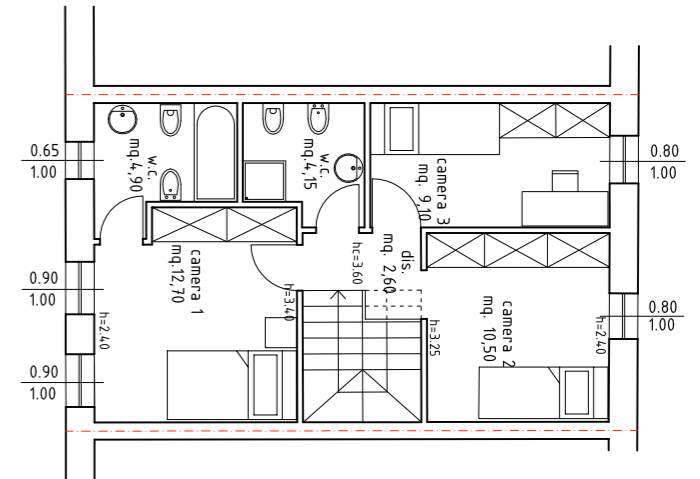
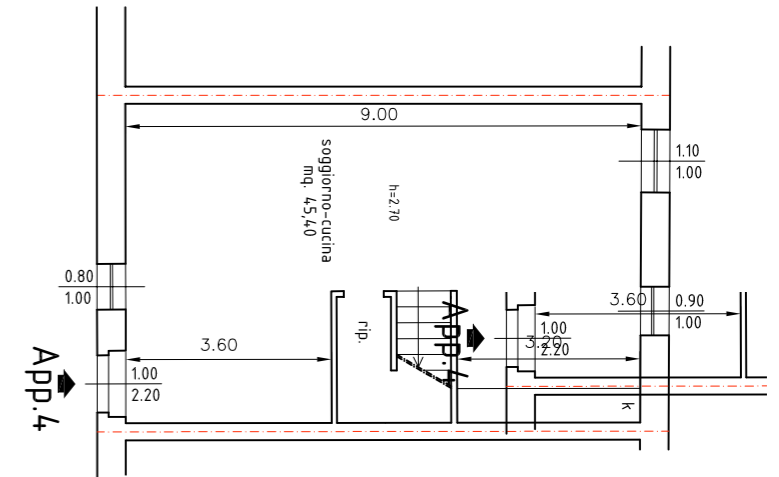

Borghetto Poggio Bianco

A historical hamlet restored into luxury countryside apartments.

Apartment five:

Type: duplex 3-bedroom apartment with kitchen and dining area living area, fireplace and terrace
 1 complete bathroom with shower
 1 private bathroom with shower and bath tub
 Ground floor and first floor
 Size: 126 m²
 Terrace: 20 m²

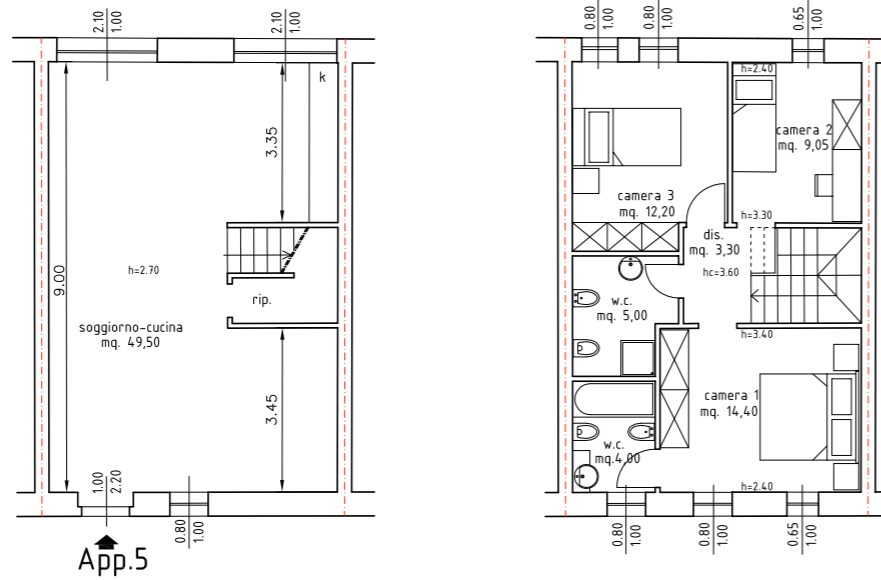

Apartment six:

Type: duplex 1-bedroom apartment with kitchen corner, living room and terrace
 1 complete bathroom with shower
 Ground floor and first floor
 Size: 68 m²
 Terrace & garden: 64 m²

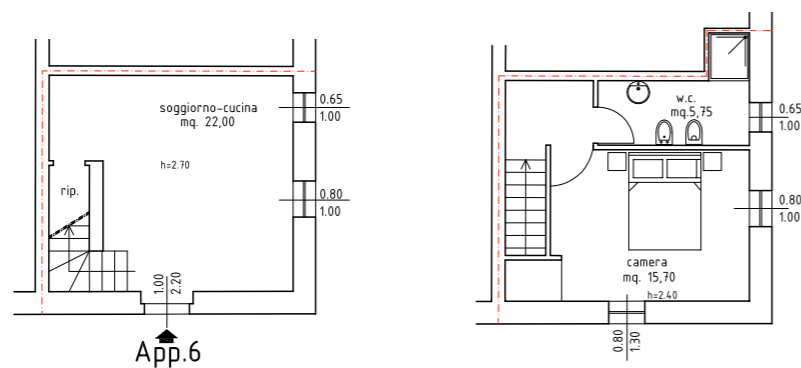

Apartment seven:

Type: duplex 1-bedroom apartment with kitchen corner, living room and terrace with garden
 1 complete bathroom with shower
 Ground floor and first floor
 Size: 64 m²
 Terrace & garden: 30 m²

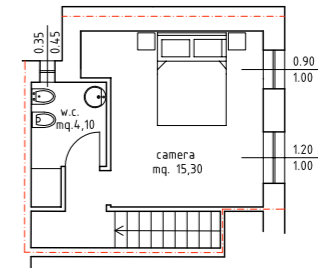
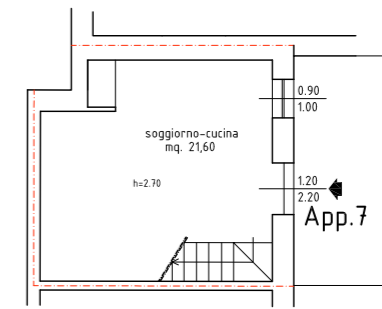

Apartment eight:

Type: Studio with kitchen corner and terrace
 1 complete bathroom with shower
 Ground floor
 Size: 40 m²
 Terrace: 28 m²

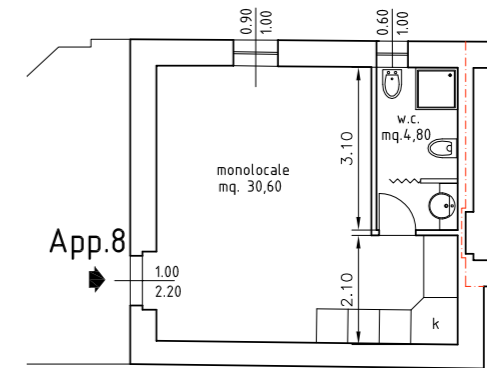

Borghetto Poggio Bianco

A historical hamlet restored into luxury countryside apartments.

Apartment nine:

Type: 1-bedroom apartment with kitchen corner, living room and terrace
 1 complete bathroom with shower
 First floor
 Size: 44 m²
 Terrace / garden: none

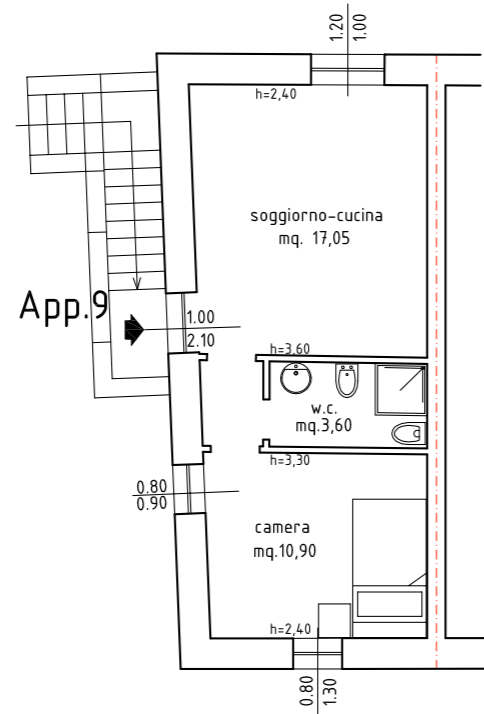

Apartment ten:

Type: 1-bedroom apartment with kitchen corner, living room and terrace with garden
 1 complete bathroom with shower
 Ground floor
 Size: 57 m²
 Terrace & garden: 225 m²

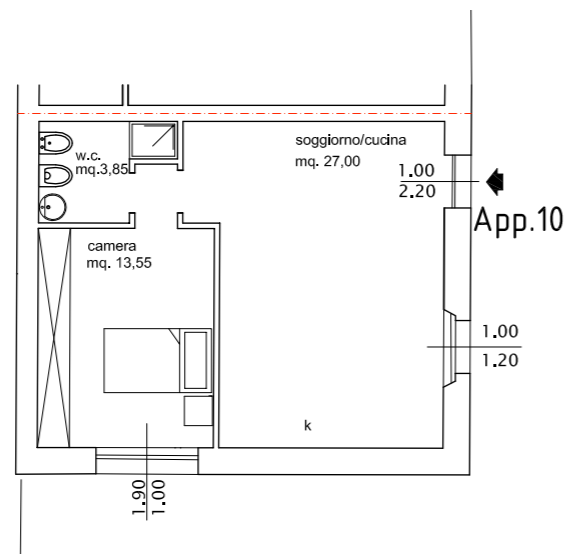

Apartment eleven:

Type: 1-room loft with kitchen corner and terrace
 1 complete bathroom with shower with jacuzzi bath tub
 First floor
 Size: 59 m²
 Terrace: 105 m²

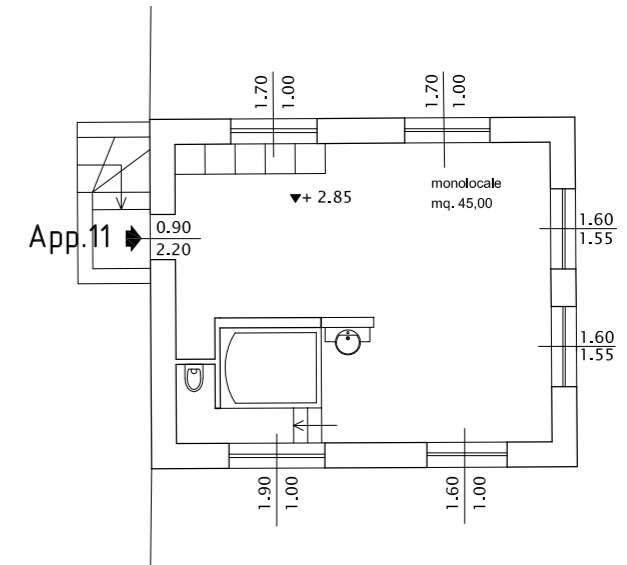

Apartment twelve:

Type: 1-bedroom apartment with kitchen corner, living room and terrace
 1 complete bathroom with shower
 Ground floor
 Size: 32 m²
 Terrace: 18 m²

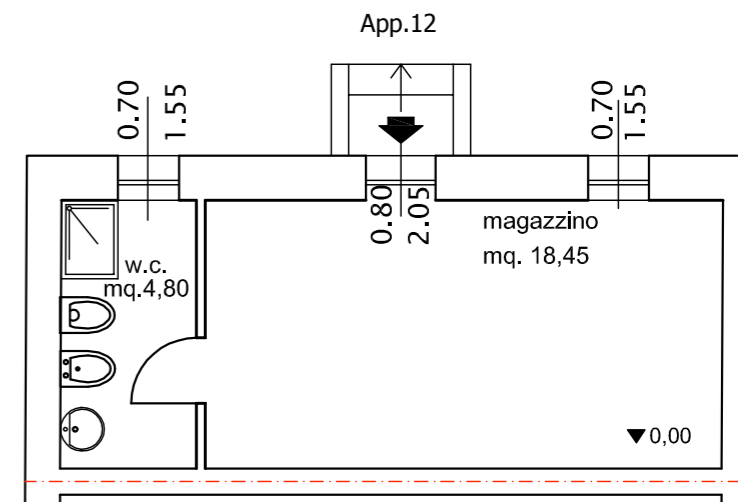

Swimming pool:

The swimming pool is 18m x 6m
There is also a storage area in the swimming pool's engine room.

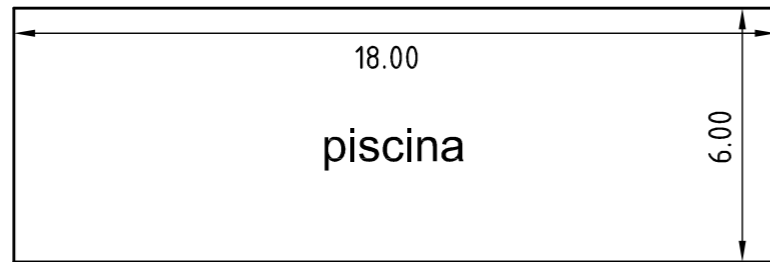

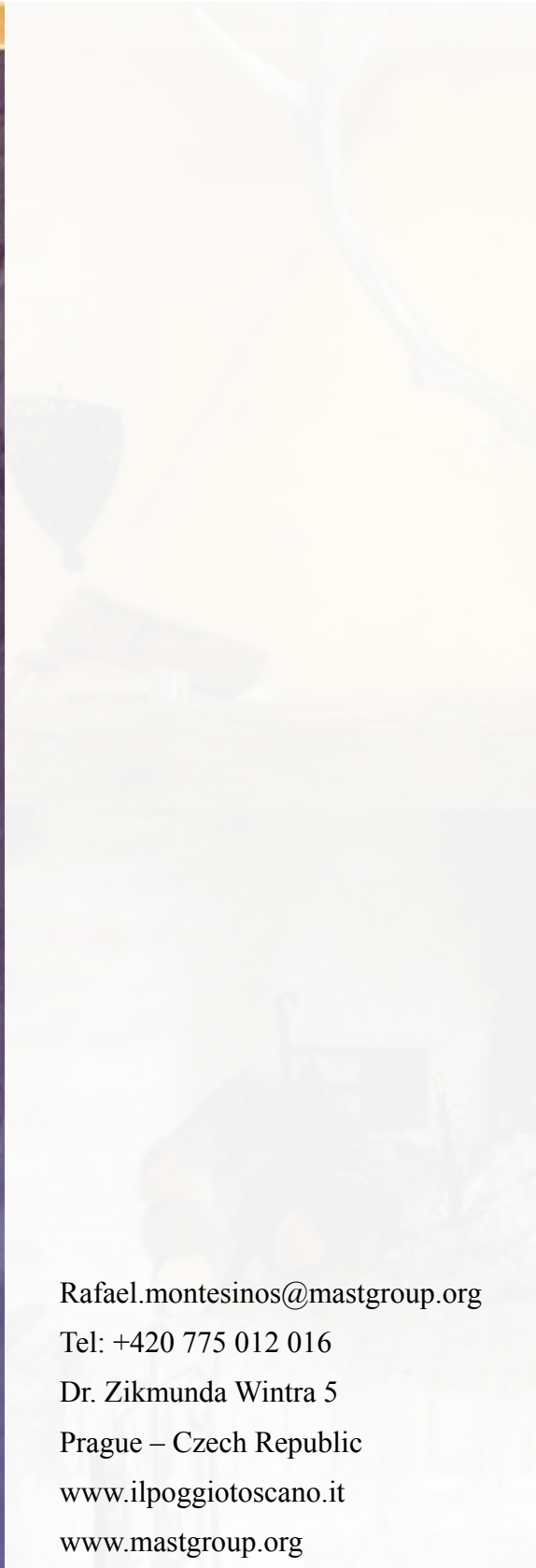

Rafael.montesinos@mastgroup.org

Tel: +420 775 012 016

Dr. Zikmunda Wintra 5

Prague – Czech Republic

www.ilpoggiotosciano.it

www.mastgroup.org

